

VELVET Mini 1 DMX IP54

Ref.: VM1IP54VLDMX

Datasheet: June 2021 / Page 1



Bicolor weatherproof compact panoramic soft light LED panels

[Click here for more product information](#)

VM1IP54VLDMX includes: integrated Vlock mount, DMX in XLR-5 connector, 1x yoke with 28mm junior pin - 16mm baby receiver



1. Power switch
2. Integrated Vlock or Gold Adapter
3. + / - Adjustment buttons
4. 3200K/5600K Quick button
5. Mode selection button (Dimmer / Colour Temperature)
6. Digital display
7. XLR-5 DMX RDM In & Out Connector



VELVET Mini 1 DMX IP54

Ref.: VM1IP54VLDMX

Datasheet: June 2021 / Page 2



| | |
|----------------------------------|---|
| COLOUR TEMPERATURE | adjustable from 2700K to 6500K in 100K increments |
| LIGHT INTENSITY | dimnable 0 to 100 (smooth and flicker-free) |
| TLCI | 95 at 3200K and 98 at 5600K |
| DIMENSIONS | 345 x 190 x 90 mm / 13,6"x7,5"x3,5" (panel) |
| WEIGHT | 1,9 kgs / 4,2 lbs (panel) |
| POWER DRAW | 50W / 0,45 Amps at 110 VAC |
| POWER SUPPLY | Vock or Gold battery mount 90-264 VAC 50/60Hz through Smart AC adapter |
| PHOTOMETRICS | 1.200 Lux / 111 fc at 1m / 3 feet 150 Lux / 14 fc at 3m / 10 feet |
| BEAM ANGLE | 100° |
| LED RATED LIFE | more than 50.000 hours |
| COOLING | no-noise, fan-free passive cooling |
| PROTECTION | IP54 weatherproof, indoor or outdoor use |
| CONSTRUCTION & FINISH | made of black anodized extruded aluminum and black powder coated sheet aluminum |
| VELVET LED TECHNOLOGY | Selected BIN LED + optic diffuser + CPU software control |
| ACCESSORIES | Smart AC power supply, VELVET DMX remote control, foldable Snapgrid, foldable SnapBag softbox, removable barn doors, cordura case, hard case |
| RIGGING OPTIONS | aluminum yoke with 16mm baby receptacle combined with 28mm junior pin, four sliding threads 1/4" for riggings located on panel sides, double baby pin for diagonal or vertical position using the standard yoke |

WIRE VIEW

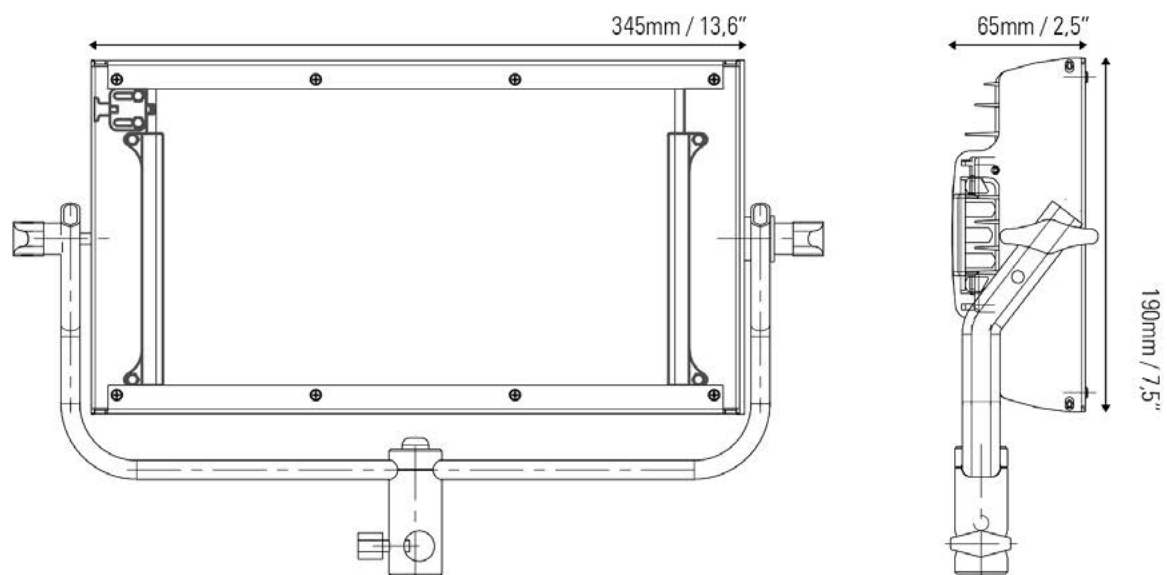

VELVET Mini 1 DMX IP54

Ref.: VM1IP54VLDMX

Datasheet: June 2021 / Page 3



PHOTOMETRICS

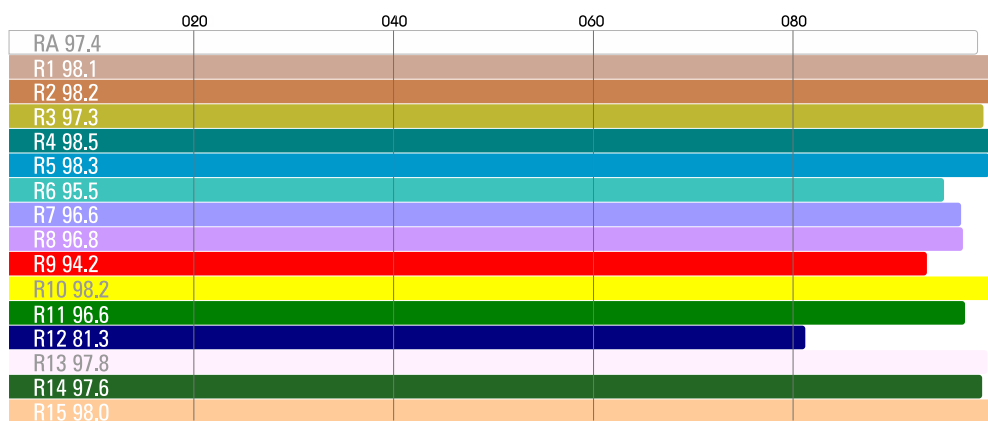
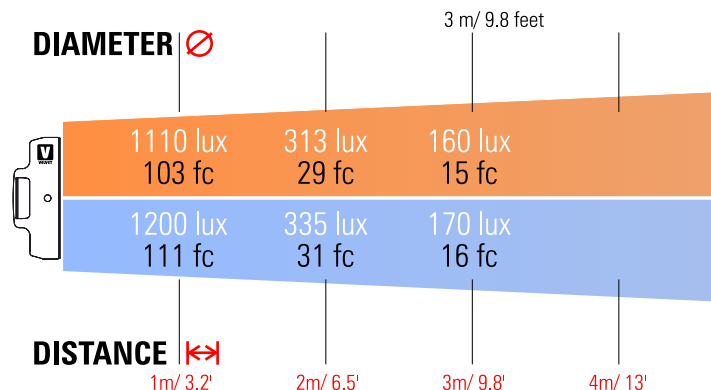

CCT 3231K

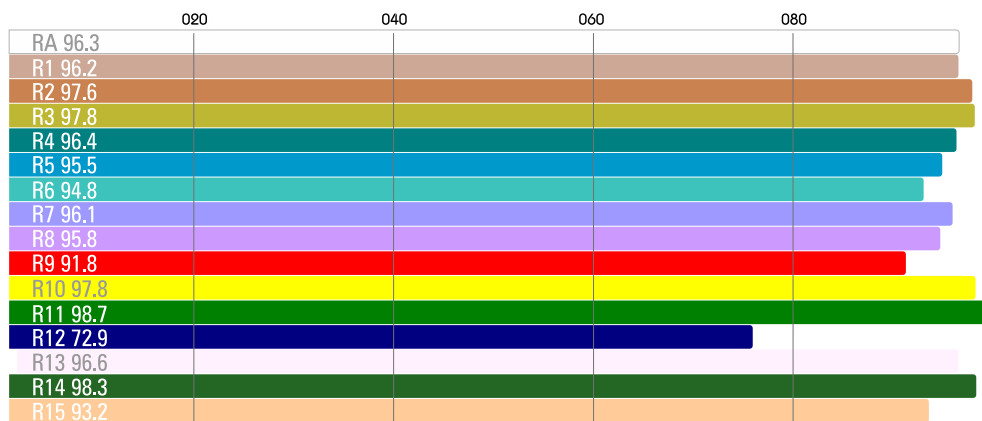

CCT 5638K







VELVET Mini 1 DMX IP54

Ref.: VM1IP54VLDMX

Datasheet: June 2021 / Page 4



ACCESSORIES

| POWER SUPPLY | | BEAM CONTROL | |
|---|---|---|---|
|  |  |  |  |
| VM1-PSU65WVL | VM1-PSU65WGL | VM1-RB | VM1-SG |
| TRANSPORT | | REMOTE CONTROL | |
|  |  |  | |
| VM1-BAG | VM1-DBAG | VL-RC | |