

VELVET Light 2 IP54

Ref.: VL2IP54NY

Datasheet: October 2023 / Page 1



**2x1 feet bicolor weatherproof,
IP54 soft light LED panel**

[Click here for more product information](#)

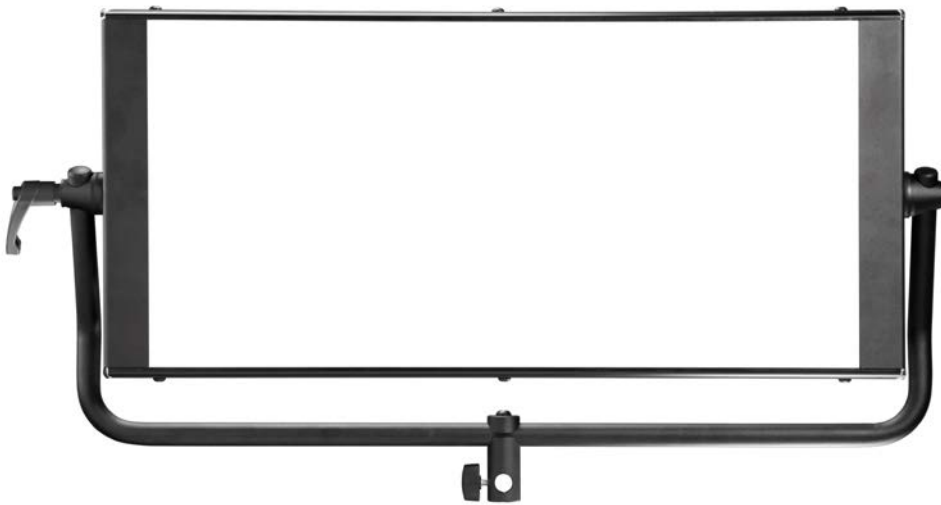

1. XLR-3 DC IN
2. Power switch
3. + / - Adjustment buttons
4. 3200K / 5600K Quick access button
5. Mode selection button (Dimmer / Colour Temp)
6. Digital display
7. XLR-5 DMX In&Out

VELVET Light 2 IP54



Ref.: VL2IP54NY

Datasheet: October 2023 / Page 2

SPECIFICATIONS

COLOUR TEMPERATURE	Adjustable from 2700K to 6500K (100K increments)
LIGHT INTENSITY	Dimmable 0 to 100 (smooth and flicker-free)
LOCAL CONTROL	Shock proof buttons and display
WIRE CONTROL	DMX-RDM with XLR-5 In & Out connectors
TLCI INDEX	95 at 3270K and 95 at 5740K
PHOTOMETRICS	6090 lux / 647 fc at 1m / 3 feet 798 lux / 73 fc at 3m / 10 feet
BEAM ANGLE	100°
DIMENSIONS	670x308x68mm / 26.4"x12"x2.7" (panel) 770x435x68mm / 30.3"x17.1"x2.7" (panel + yoke)
WEIGHT	5.9 kg / 13 lbs (panel) 6.5 kg / 14.3 lbs (panel + yoke)
POWER DRAW	160W (0.70A at 220VAC — 1.45A at 110VAC)
POWER SUPPLY	24-35V DC V-Lock or Gold mount battery plate 90-264V AC 50/60Hz
LED RATED LIFE	More than 50.000 hours L70 More than 35.000 hours L80
POWER CONNECTION	Neutrik XLR-3 DC In connector
OUTPUT FREQUENCY	2000 fps
OPERATION TEMPERATURE	From -20°C to +40°C
COOLING	No-noise, fan-free passive cooling
PROTECTION	IP54 rainproof, indoor or outdoor use
VELVET LED TECHNOLOGY	Selected BIN LED + optic diffuser + CPU software control
RIGGING OPTIONS	Aluminum yoke with 16 female combined with 28 pin, quick link swivel ball head, pole operated yoke, multipanel yokes
QUICK MOUNTING ACCESSORIES	AC power supply, Vlock or Gold adapter, DMX 512 splitter cable in&out, foldable Snapgrid, removable barn doors, cordura case, hard case
CONSTRUCTION & FINISH	Black anodized extruded aluminum and black powder coated sheet aluminum

VELVET Light 2 IP54 + MO Yoke

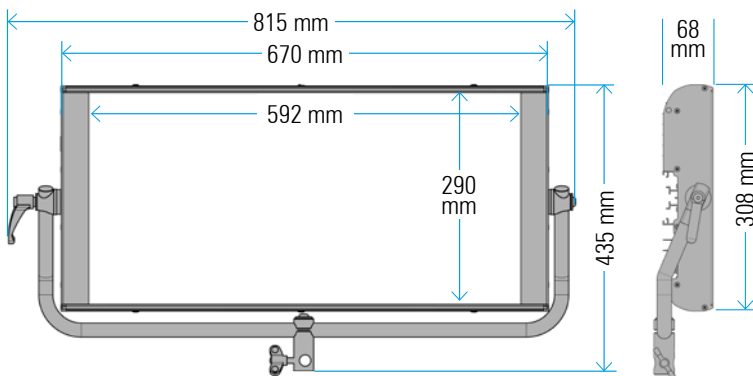

VELVET Light 2 IP54 + PO Yoke

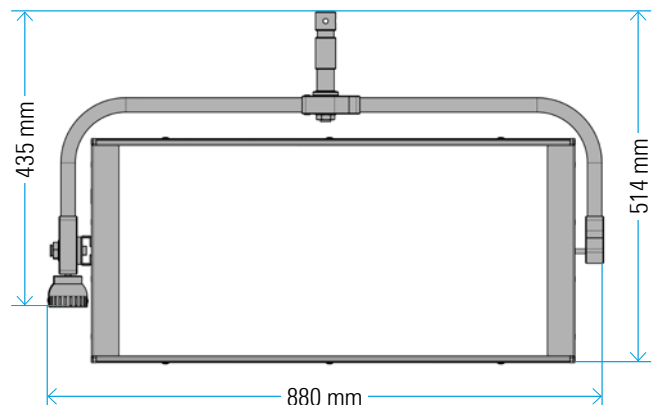

VELVET Light 2 IP54

Ref.: VL2IP54NY

Datasheet: October 2023 / Page 3



PHOTOMETRICS

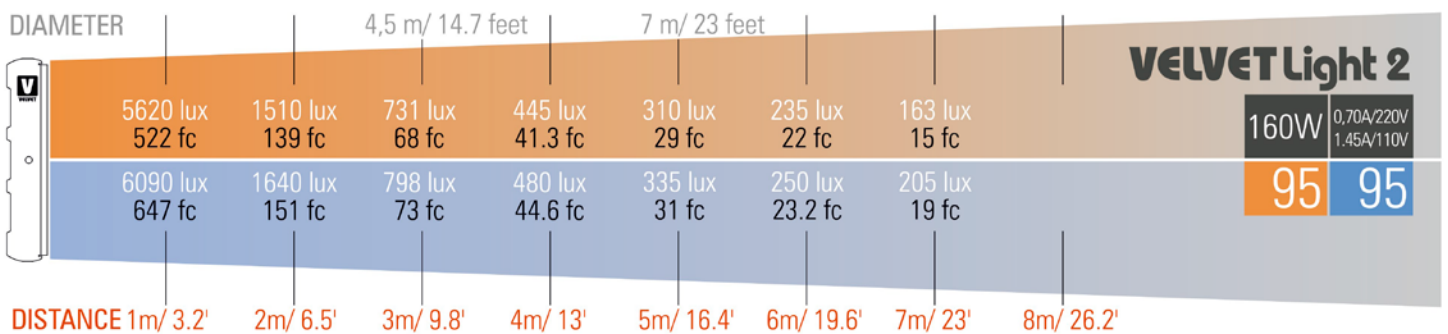
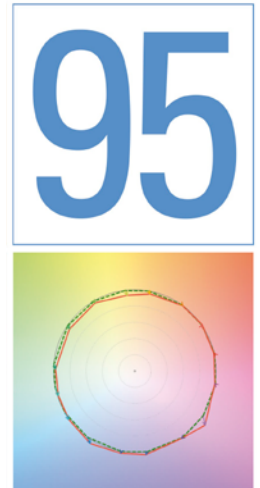
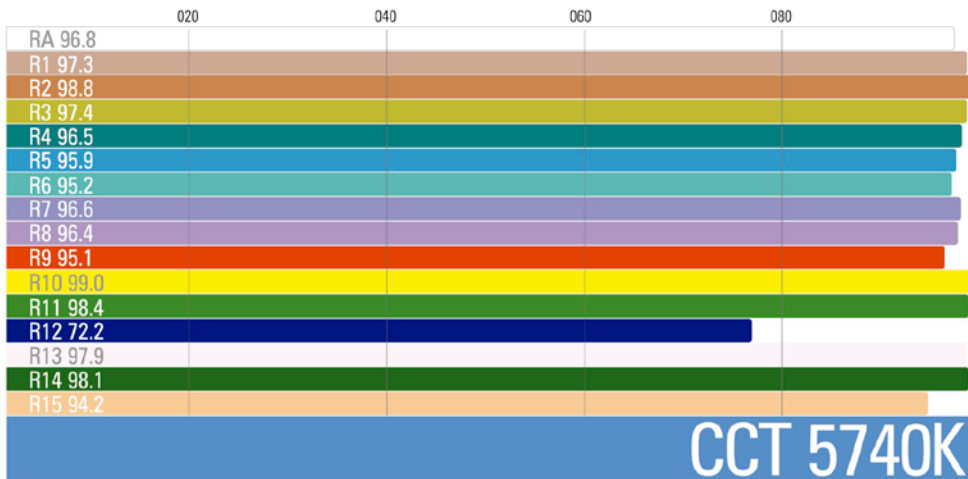
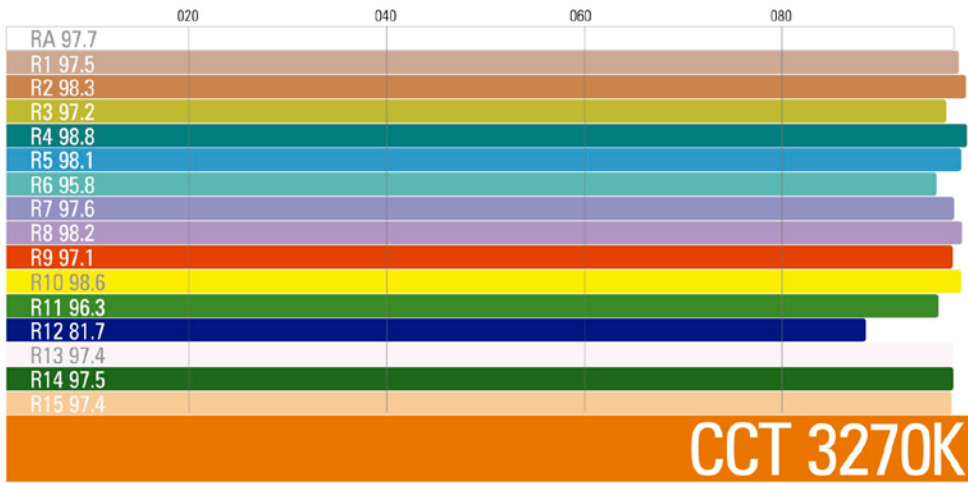















VELVET Light 2 IP54

Ref.: VL2IP54NY

Datasheet: October 2023 / Page 4



ACCESSORIES

POWER SUPPLY		BATTERY ADAPTERS	
 VL-PSU180W	 VLIP54-PSU180W	 VL2-VLOCK	 VL2-GOLD
BEAM CONTROL			
 VL2-RB	 VL2-SG	 VL2-SG20	
 VL2-SG60	 VL2-SB	 VL2-SGXSB	
TRANSPORT		RIGGING	REMOTE CONTROL
 VL2-BAG	 VL2-CASE	 VL2-QLS	 VL-RC