

## 2x2 feet weatherproof soft light LED panel R+G+B+W+CW with wireless control

EVO 2x2 is a weatherproof IP54 color panel with a 100% aluminum housing, designed specifically to endure the toughest working conditions in wet or dusty locations. It delivers the same full output powered by a 28V battery as it does from AC power and includes built-in wireless DMX LumenRadio, Art-Net Wi-Fi and Bluetooth to remotely control through VELVET GOYA free App.

[Click here for more product information](#)

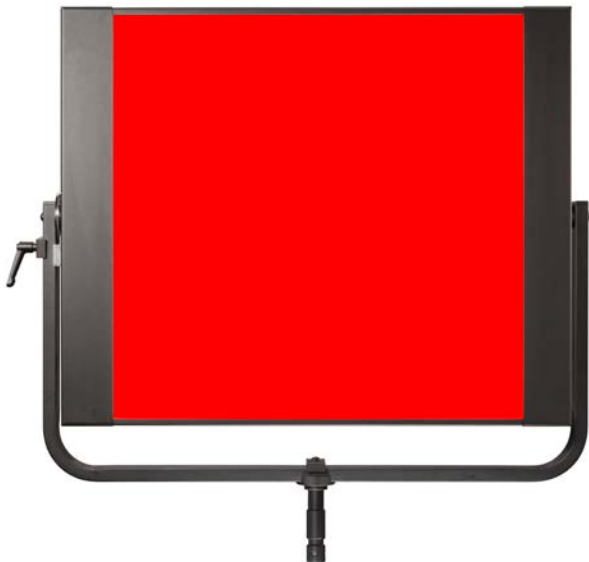

1. RJ-45 Ethercon Lan connector
2. XLR-5 DMX RDM In & Out connector
3. Light power button
4. Up and down scroll buttons
5. Enter/+ & - adjustment button
6. 3200K / 5600K quick access button
7. Mode selection/ Lock button
8. Back button
9. Micro USB connector
10. Main power switch
11. XLR-3 DC In connector



SPECIFICATIONS	
COLOUR TEMPERATURE	Continuously adjustable from 2500K to 10000K
GREEN-MAGENTA	Continuously adjustable from full minusgreen to full plusgreen
COLOR SPECTRUM	Full color spectrum R+G+B+W+CW with hue, saturation, and base colortemperature control
CONTROL COLOR MODES	CCT, HSI, RGB, Gels and Effects base Kelvin white light can be set combined with any color
LIGHT INTENSITY	Dimmable 0 to 100, smooth and flicker-free
LOCAL CONTROL	With 8x shock resistant buttons and color display
WIRE CONTROL	DMX-RDM with XLR-5 in connector
WIRELESS CONTROL	DMX-RDM with LumenRadio, CRMX Wi-Fi Art-Net + VELVET Goya App, Bluetooth
TLCI INDEX	96 at 3344K and 96 at 5528K
PHOTOMETRICS	15805 Lux / 1468 fc at 1m / 3,2 feet 2405 Lux / 223 fc at 3m / 10 feet
BEAM ANGLE	115°
DIMENSIONS	763 x 620 x 93mm / 30 x 24.4 x 3.6 inches
WEIGHT	13 kg / 28.6 lbs (panel) 15.3 kg / 33.7 lbs (panel + yoke)
POWER DRAW	403W (1.75A at 220VAC — 3.6A at 110VAC)
POWER SUPPLY	28V DC (XLR3). 90-264V AC 50/60Hz
LED RATED LIFE	More than 50.000 hours
POWER CONNECTION	Neutrik PowerCon TRUE1 TOP In connector
OUTPUT FREQUENCY	2000 fps
OPERATION TEMPERATURE	From -20°C to +40°C
COOLING	Silent and fan-free pasive cooling
PROTECTION	IP54 weatherproof, indoor or outdoor use
VELVET LED TECHNOLOGY	Selected BIN LED core unit + optic diffuser + CPU software control
RIGGING OPTIONS	Aluminum yoke with 16mm baby receptacle combined with 28mm junior pin, multiple 1/4"- 20 rigging points, pole operated yoke.
QUICK MOUNTING ACCESSORIES	Foldable SnapBag, foldable Snapgrid, removable barn doors, cordura case, hard case
CONSTRUCTION & FINISH	Fixture and yoke made of black powdercoated extruded and sheet aluminum

**WIRE VIEW**

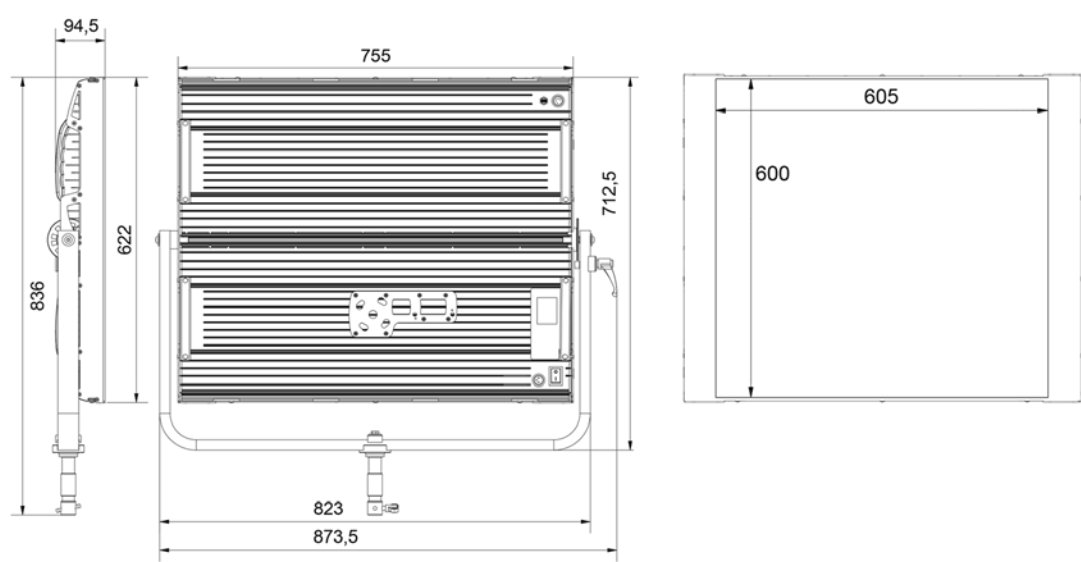

**PHOTOMETRICS**

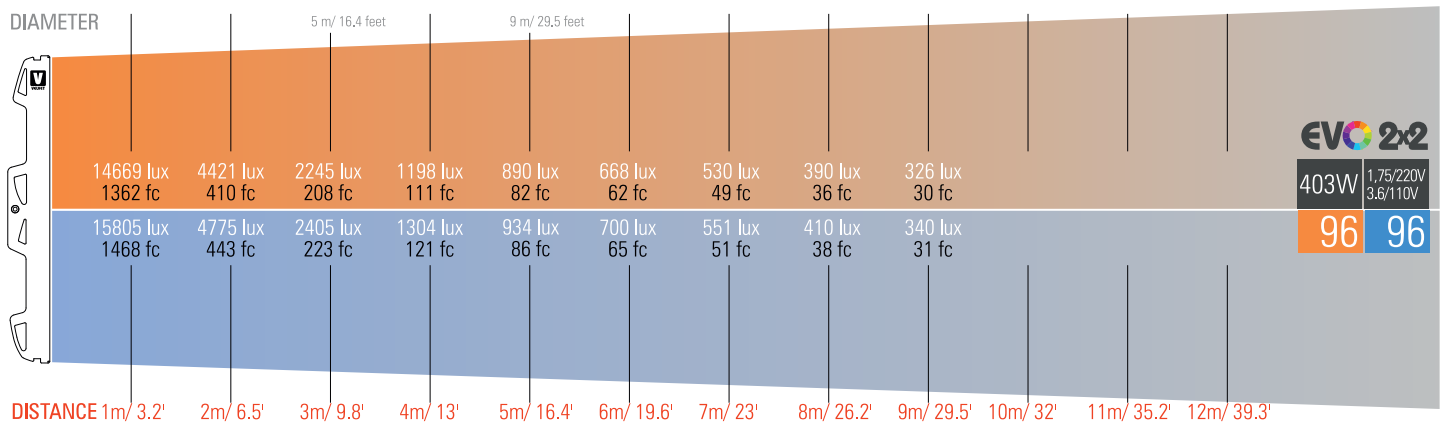
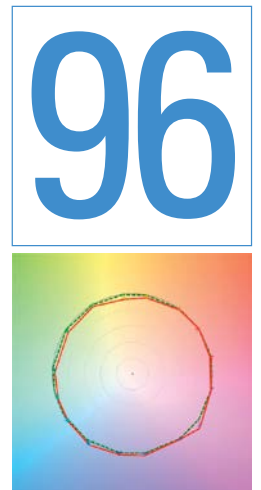
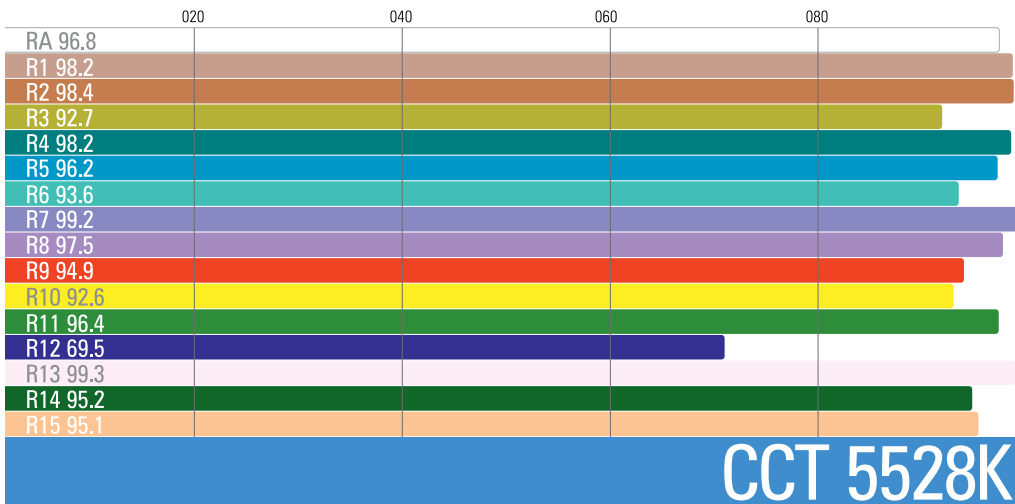
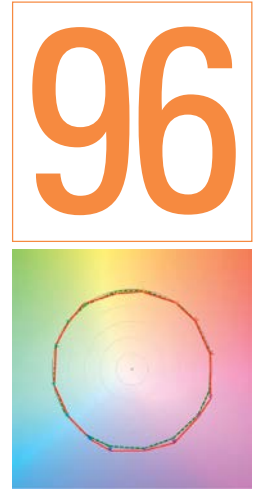
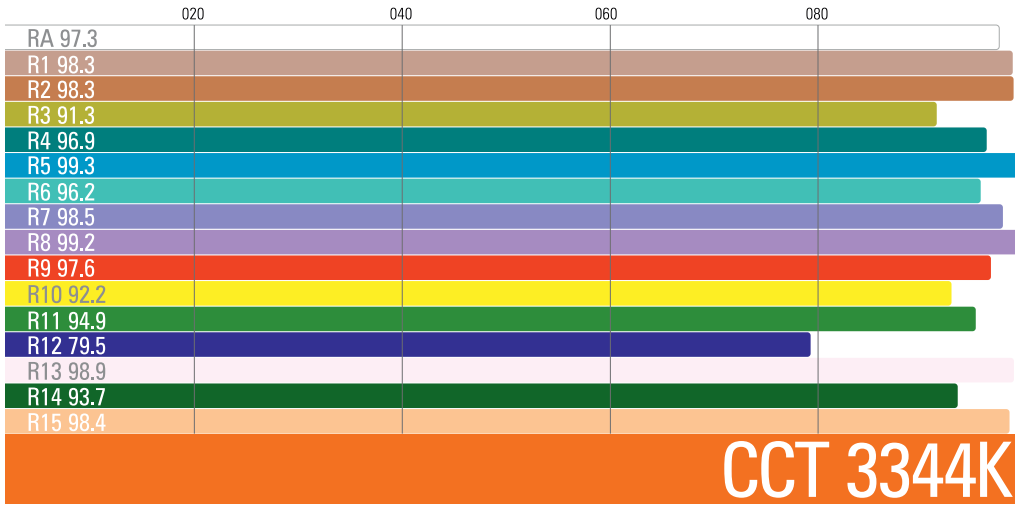

**ACCESSORIES**

POWER SUPPLY	TRANSPORT	RIGGING	REMOTE CONTROL
--------------	-----------	---------	----------------



VEIP-PSU400W



VE2X2-CASE



VE2X2-YPO



VE2X2-YPO

**BEAM CONTROL**



VE2X2-RB



VE2X2-SG



VE2X2-SB



VE2X2-SGXSB

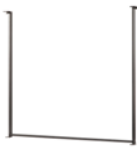

VE2X2-SLOTKIT



2X2-RABBITSQ



OCTA-SBR05



OCTA5-SG



OCTA-SBR07



OCTA7-SG