

1x1 foot dustproof AC powered soft light LED panels R+G+B+W+CW with wireless control

Natural soft light color 5LED panel. Dustproof IP51 rated. High color reproduction. High SSI, TLCI & CRI (96). Perfect skin tones and real colors. Robust and lightweight low-carbon aluminum body. Totally silent fanless operation. High efficiency: best lux/watt ratio on the market. RJ-45 ethernet, Wi-fi Artnet, Bluetooth. AC and DMX-RDM In-Out built-in connectors.

More info

[Website](#)

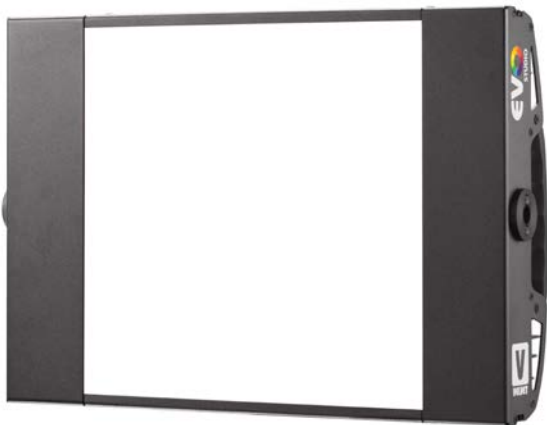

1. Accessories mounting plate
2. XLR-5 DMX-RDM In & Out connector
3. Light power button
4. Digital display
5. Up and down scroll buttons
6. Enter / +/- Adjustment buttons
7. 3200K / 5600K quick access button
8. Back button
9. Mode selection / Lock button
10. Mini USB connector
11. Main power switch
12. Ethernet RJ-45 LAN connector
13. XLR-3 DC In connector



SPECIFICATIONS

COLOUR TEMPERATURE	Continuously adjustable from 2500K to 10000K
GREEN-MAGENTA	Continuously adjustable from full minusgreen to full plusgreen
COLOR SPECTRUM	Full color spectrum R+G+B+W+CW with hue, saturation, and base colortemperature control
CONTROL COLOR MODES	CCT, HSI, RGB, Gels and Effects base Kelvin white light can be set combined with any color
LIGHT INTENSITY	Dimmable 0 to 100, smooth and flicker-free
LOCAL CONTROL	With 8x shock resistant buttons and color display
WIRE CONTROL	DMX-RDM with XLR-5 In & through connectors, Ethernet Art-Net with RJ-45 connector
WIRELESS CONTROL	Wi-Fi Art-Net +VELVET Goya App
TLCI INDEX	96 at 3200K and 97 at 5600K
PHOTOMETRICS	4591 lux / 423 fc at 1m / 3 feet 656 lux / 61 fc at 3m / 10 feet
BEAM ANGLE	115°
DIMENSIONS	453 x 318 x 128mm / 17.8 x 12.5 x 5 inches
WEIGHT	5.6 kg / 12.3 lbs (panel) 6.1 kg / 14.4 lbs (panel + yoke)
POWER DRAW	112W (0.47A at 220VAC — 1.0A at 110VAC)
POWER SUPPLY	90-264V AC 50/60Hz
LED RATED LIFE	More than 50.000 hours
POWER CONNECTION	Neutrik PowerCon TRUE1 TOP In connector
OUTPUT FREQUENCY	2000 fps
OPERATION TEMPERATURE	From -20°C to +40°C
COOLING	Silent and fan-free pasive cooling
PROTECTION	IP51 dustproof, indoor or outdoor use
VELVET LED TECHNOLOGY	Selected BIN LED core unit + optic diffuser + CPU software control
RIGGING OPTIONS	Aluminum yoke with 16mm baby receptacle combined with 28mm junior pin, multiple 1/4"- 20 rigging points, pole operated yoke.
QUICK MOUNTING ACCESSORIES	Foldable SnapBag, foldable Snapgrid, removable barn doors, cordura case, hard case
CONSTRUCTION & FINISH	Fixture and yoke made of black powdercoated extruded and sheet aluminum

WIRE VIEW

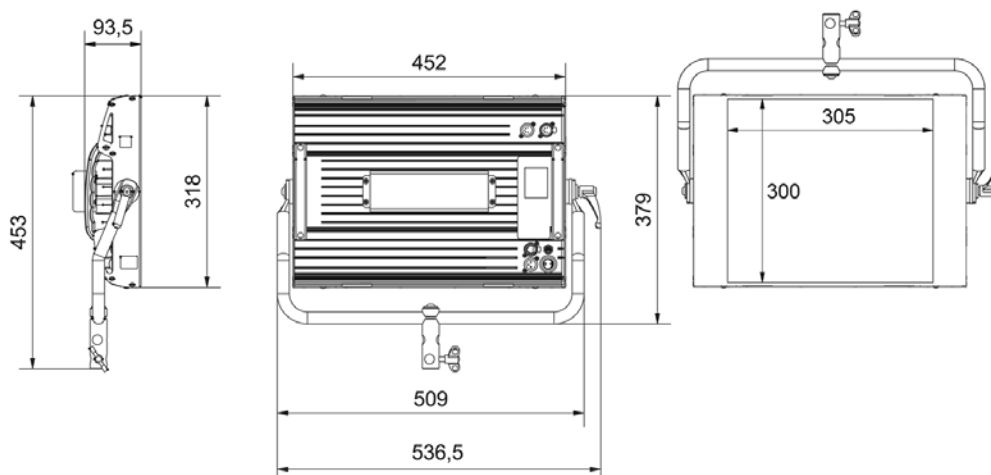

PHOTOMETRICS

